

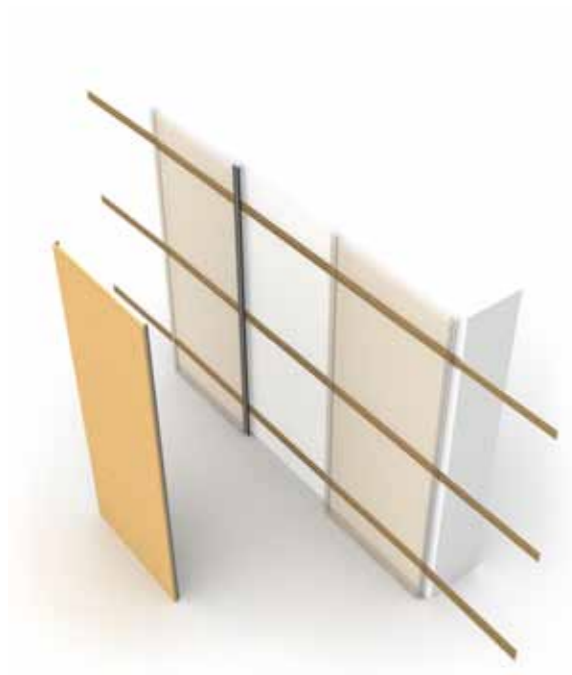

Wall Lining Module.

Contents

1 x Reform Lining (RFLE) 2440 / 3000
MDF Option - 1 x Reform Panel (RFP/MDF) @ 2440 x 750/950 x thickness



Wall Lining Module.

Contents

1 x Reform Lining (RFLE) 2440 / 3000
Acrylic Option - 1 x Reform Panel (RFP/ACR) @ 2440 x 750/950 x thickness

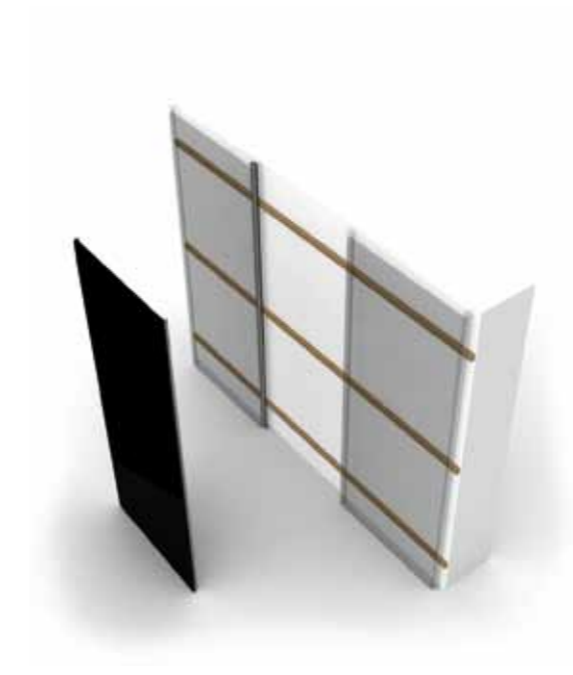

Wall Lining Module.

Contents

1 x Reform Lining (RFLE) 2440 / 3000
Composite Aluminium Panel Option - 1 x Reform Panel (RFP/CAP) @ 2440 x 750/950 x thickness

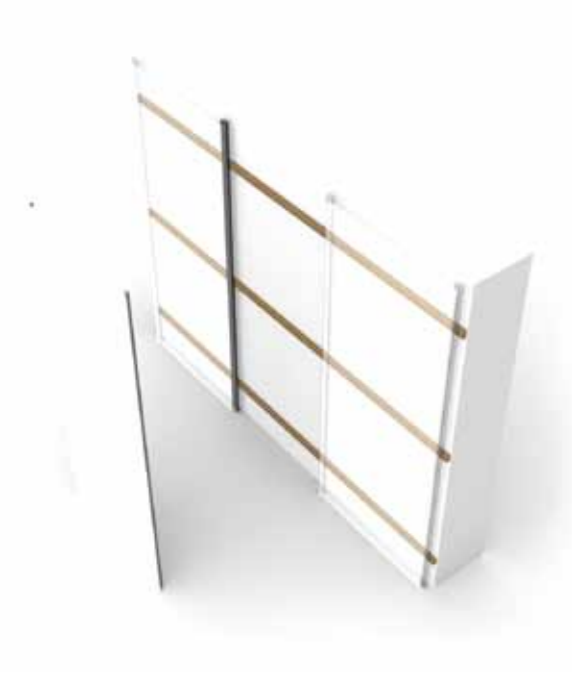

2440mm Single Sided Wall Module.

Contents



1 x Reform Upright (RFU) 2440
Straight Bay Option - 1 x Reform Rails (RFR) @ 750/950 1 x Reform Rail Wide (RFRW) @ 750/950 or Curved Bay Option - 1 x Reform Rails (RFRC) @ R <i>*(See components page)</i> 1 x Reform Rail Wide (RFRWC) @ R <i>*(See components page)</i>
MDF Option - 1 x Reform Panel (RFP/MDF) @ 2440 x 750/950 x thickness or Acrylic / Composite Aluminium Panel Option - 1 x Reform Panel (RFP/Di) @ 2440 x module width x 3mm *other options available upon request, curved or straight.

2440mm Double Sided Wall Module.

Contents

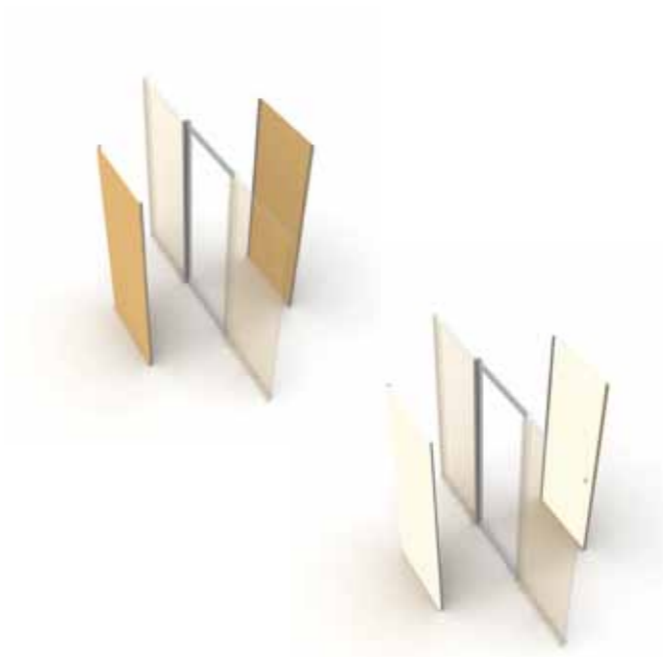

1 x Reform Upright (RFU) 2440
Straight Bay Option - 1 x Reform Rails (RFR) @ 750/950 1 x Reform Rail Wide (RFRW) @ 750/950 or Curved Bay Option - 1 x Reform Rails (RFRC) @ R <i>*(See components page)</i> 1 x Reform Rail Wide (RFRWC) @ R <i>*(See components page)</i>
MDF Option - 2 x Reform Panel (RFP/MDF) @ 2440 x module width x thk or Acrylic / Composite Aluminium Panel Option - 2 x Reform Panel (RFP/Di) @ 2440 x module width x 3mm *other options available upon request, curved or straight.

3000mm Single Sided Wall Module.

Contents



1 x Reform Upright (RFU) 3000
Straight Bay Option - 2 x Reform Rails (RFR) @ 750/950 1 x Reform Rail Wide (RFRW) @ 750/950 or Curved Bay Option - 2 x Reform Rails (RFRC) @ R <i>*(See components page)</i> 1 x Reform Rail Wide (RFRWC) @ R <i>*(See components page)</i>
MDF Option - 1 x Reform Panel (RFP/MDF) @ 3000 x module width x thk or Acrylic / Composite Aluminium Panel Option - 1 x Reform Panel (RFP/Di) @ 3000 x module width x 3mm *other options available upon request, curved or straight.

3000mm Double Sided Wall Module.

Contents

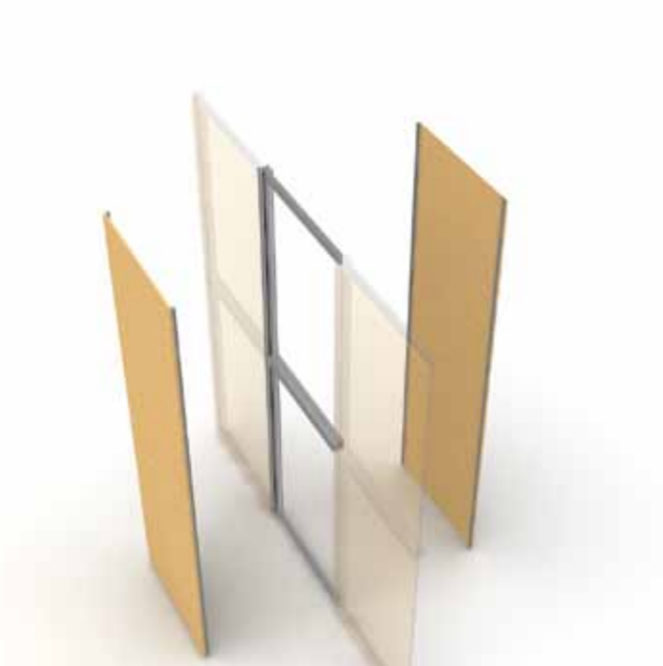

1 x Reform Upright (RFU) 3000
Straight Bay Option - 2 x Reform Rails (RFR) @ 750-950 1 x Reform Rail Wide (RFRW) @ 750-950 or Curved Bay Option - 2 x Reform Rails (RFRC) @ R <i>*(See components page)</i> 1 x Reform Rail Wide (RFRWC) @ R <i>*(See components page)</i>
MDF Option - 2 x Reform Panel (RFP/MDF) @ 3000 x module width x thk or Acrylic / Composite Aluminium Panel Option - 2 x Reform Panel (RFP/Di) @ 3000 x module width x thk *other options available upon request, curved or straight.

Wide Bay at 2440mm / Double Sided Module.

Contents

2 x Reform Upright (RFU) 2440
Straight Bay Option - 4 x Reform Rails (RFR) @ 750/950 2 x Reform Rail Wide (RFRW) @ 750/950 2 x Reform Cross Brace (RFCB)
MDF Option - 2 x Reform Panel (RFP/MDF) @ 2440 x module width x thk

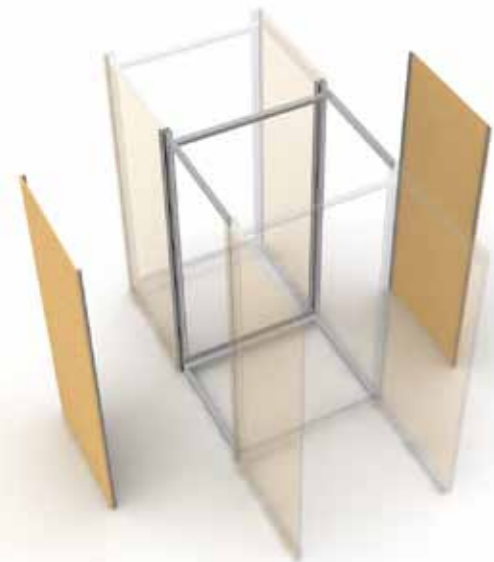

End Panel Wide Bay.

Contents

2440mm Option
2 x Reform Half Upright (RFHU) 2440
MDF - 1 x Reform End Panel (RFE) @ 2440 x Width
3000mm Option
2 x Reform Half Upright (RFHU) 3000
MDF - 1 x Reform End Panel (RFE) @ 3000 x Width
Additional Door
MDF - 1 x Reform End Door (RFED)

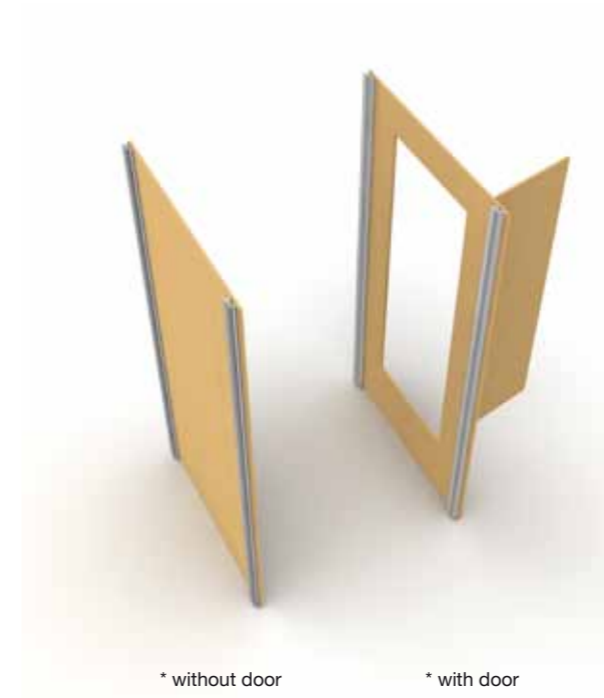

Wide Bay at 3000mm / Double Sided Module.

Contents

2 x Reform Upright (RFU) 3000
Straight Bay Option - 4 x Reform Rails (RFR) @ 750/950 2 x Reform Rail Wide (RFRW) @ 750/950 3 x Reform Cross Brace (RFCB)
MDF Option - 2 x Reform Panel (RFP/MDF) @ 3000 x module width x thk

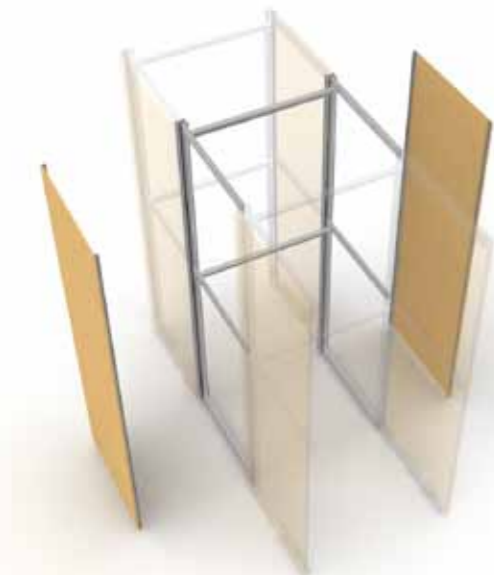

End Panel Thin Bay.

Contents

2440mm Option
2 x Reform Half Upright (RFHU) 2440
MDF - 1 x Reform End Panel (RFE) @ 2440 x 188
3000mm Option
2 x Reform Half Upright (RFHU) 3000
MDF - 1 x Reform End Panel (RFE) @ 3000 x 188



Wide Bay at 4000mm / Double Sided Module.

Contents

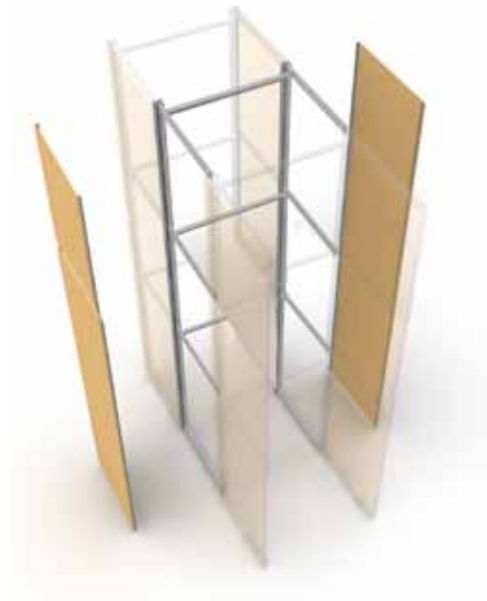

2 x Reform Upright (RFU) 4000
Straight Bay Option - 6 x Reform Rails (RFR) @ 750/950 2 x Reform Rail Wide (RFRW) @ 750/950 3 x Reform Cross Brace (RFCB)
MDF Option - 2 x Reform Panel (RFP/MDF) @ 4000 x module width x thk

Extrusion

Reform Lining RFLE

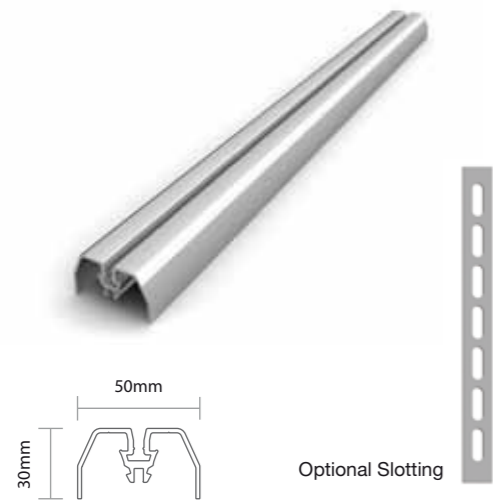

Reform Lining (RFLE) @ length

Common Link CLE



Common Link (CLE)

Rail With Locks CRE



Straight Option - Common Rail (CRE) @ length

Curved Option - Type A - (CRC) @ R7917
Type B - (CRC) @ R3142
Type C - (CRC) @ R1232

Wide Rail With Locks CRWE

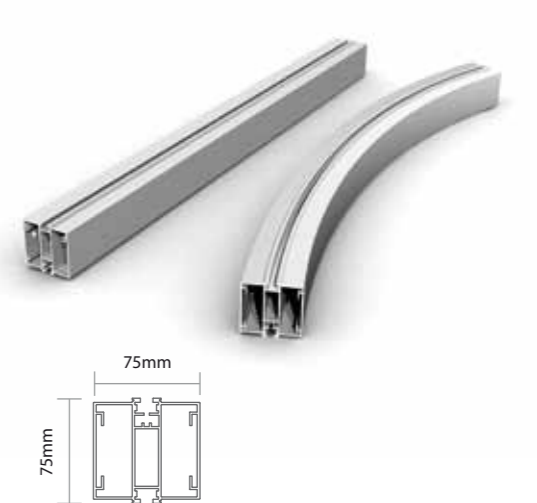

Straight Option - Common Rail Wide (CRW) @ length

Curved Option - Common Rail Wide Curved (CRWC)
Available on request

Full Upright RFUE

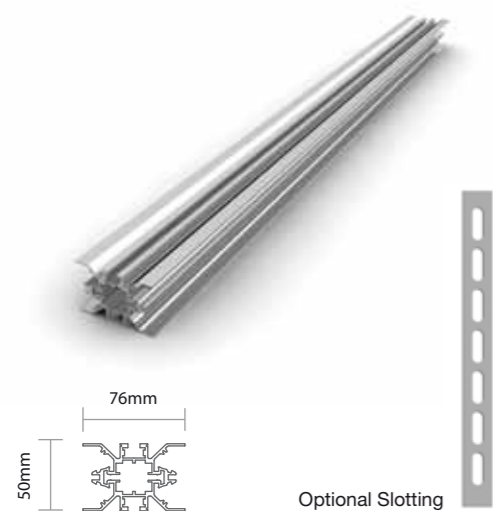

Reform Full Upright (RFUE) @ length

Half Upright RFHUE

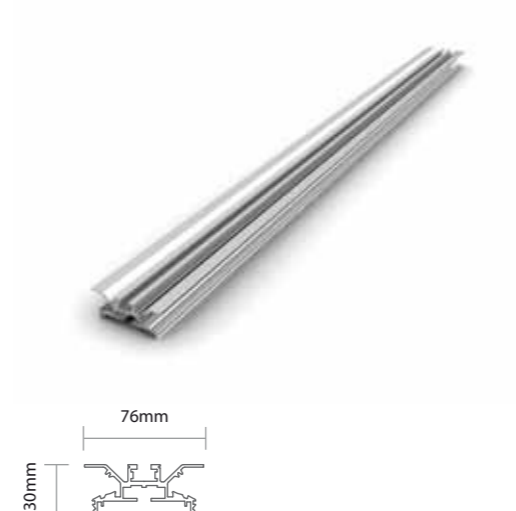

Reform Half Upright (RFHUE) @ length

Components

End Capping RFECE



Reform EndCap (RFECE) @ length

Ceiling Spigot RCS



Reform Ceiling Spigot (RCS)

Clip RFC



Reform Clip (RFC) @ length

Adjustable Foot RAF



Reform Adjustable Foot (RAF)

Standard Joints

Corners

Ends

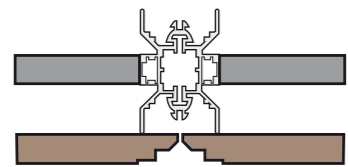

B

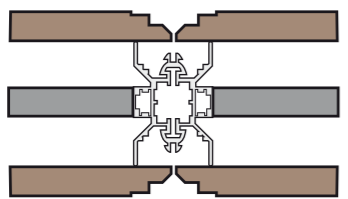

K

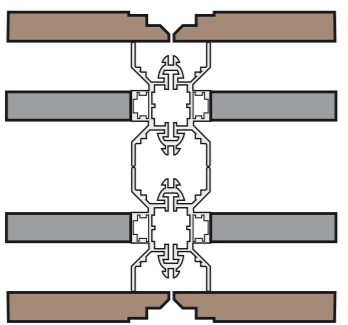

L

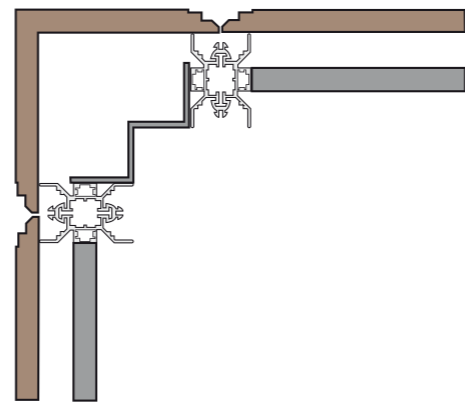

A

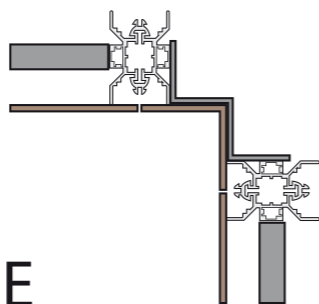

E

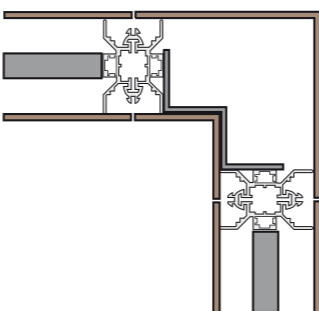

G

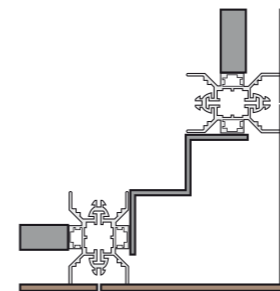

F

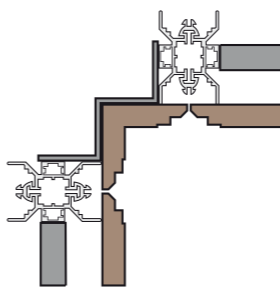

H

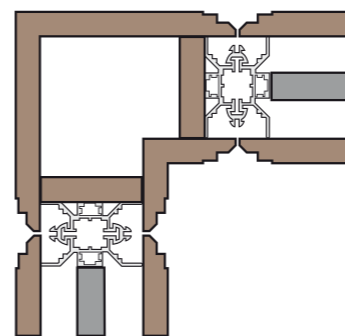

D

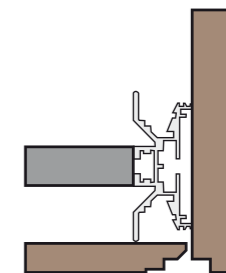

C

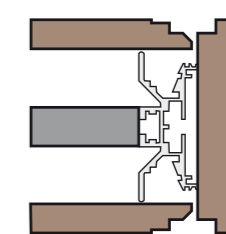

J



I

protean
reform

Productguide

s d e a
Shop and Display Equipment Association



ISO 14001
EMS 536190

@ sales@protean.uk.com
☎ +44 (0) 1280 706060
🌐 www.protean.uk.com